



Catalyst Pro

The Evolution of Under Canopy Lighting

The Catalyst® Pro is the next-generation under canopy lighting solution designed for high-performance cannabis cultivation. The Catalyst® Pro delivers greater output, extended coverage, and advanced thermal efficiency. Engineered with a broad spectrum and multiple power options, it seamlessly integrates into your grow environment to unlock massive flower potential from below the canopy—without disrupting daily operations.

Higher Yields, Better Quality, & Reduced Maintenance



Increased Yields
Grow up to 40% more premium flower



Improved Durability
Built to withstand harsh under canopy conditions

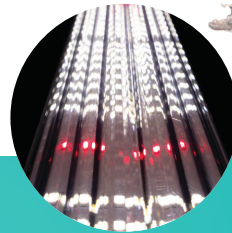

High Efficiency Lens
Improved lightfall and better directionality



Stationary Lights
Supports fast room turnover with minimal disruption

Key Benefits

✦ Higher Output

The highest available under canopy light output with up to 930 umols/s.

✦ Spectrum Options

Two broad spectrum options: 34% and 53% Red. Available in 260 and 340 Watt versions for single and dual row growing.

✦ Extended Coverage

Up to 106" length covers entire bench width, edge to edge.

✦ Easy Integration

Mounts on trellis bars or racks with minimal labor, or can be used on feet or stands—ideal for both new installs and retrofits.

✦ Made in the USA

Our lights are designed, assembled, and quality tested in the USA, ensuring reliable quality control and superior customer service.

✦ Stationary Placement

Reducing setup time for the next run and saving on labor costs.

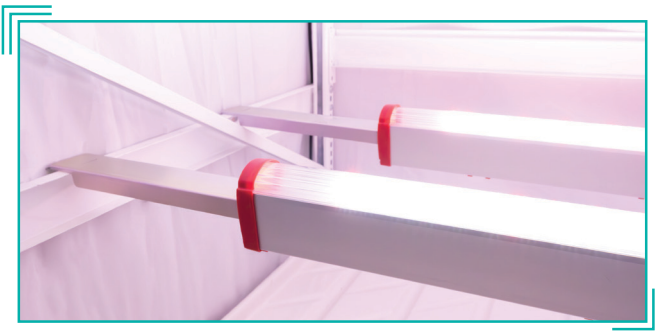

Boost Premium Yield up to 40%

Extend light deeper into the canopy and convert more of your crop into high-quality product.

Key Features

✦ New High Efficiency Lens

The new high efficiency lens (patent pending) provides improved lightfall and better directionality—they're also easy to clean!

✦ Optimized Light Spectrum

Balanced broad spectrum to support plants and reduce photobleaching risk.

✦ Waterproof

Rated IP66 for harsh environments and daily cleaning.

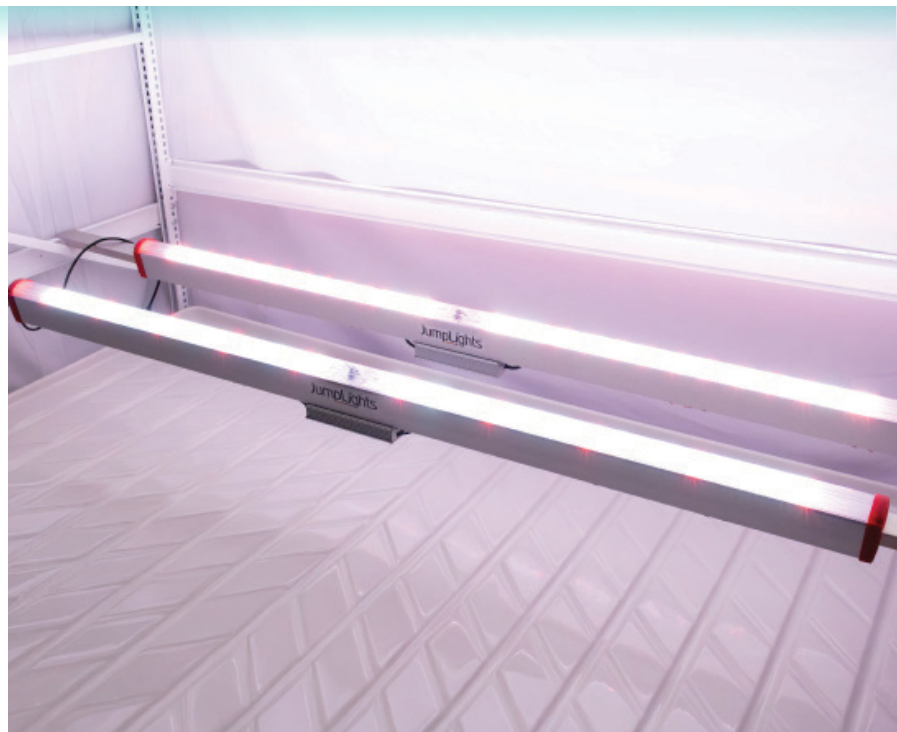

Catalyst Pro

Key Attributes

UL 8800

Industry-leading wet location certified — passes internal pressure washing test.

Bench Length

Expandable 84" - 106" fixture length reduces the number of connection needed and points of failure.

Polycarbonate Lens

Light shaping lens that protects and is easy to clean.

Waterproof Daisy Chain Connections

Design of heat sink extrusion allows for proper heat dissipation while also creating a recessed area for electrical components to be protected from the elements.

High-Quality LED Diodes

High-quality bins from a leading manufacturer ensure long-term performance and reliability.

Extendable Mounting Caps

Designed to seamlessly integrate into existing bench and racking systems.

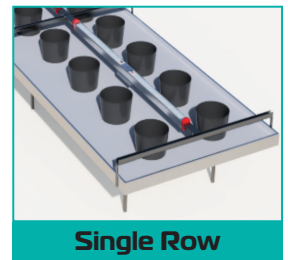
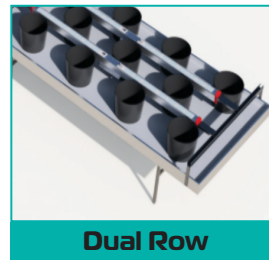

Catalyst[®] Pro Dimensions

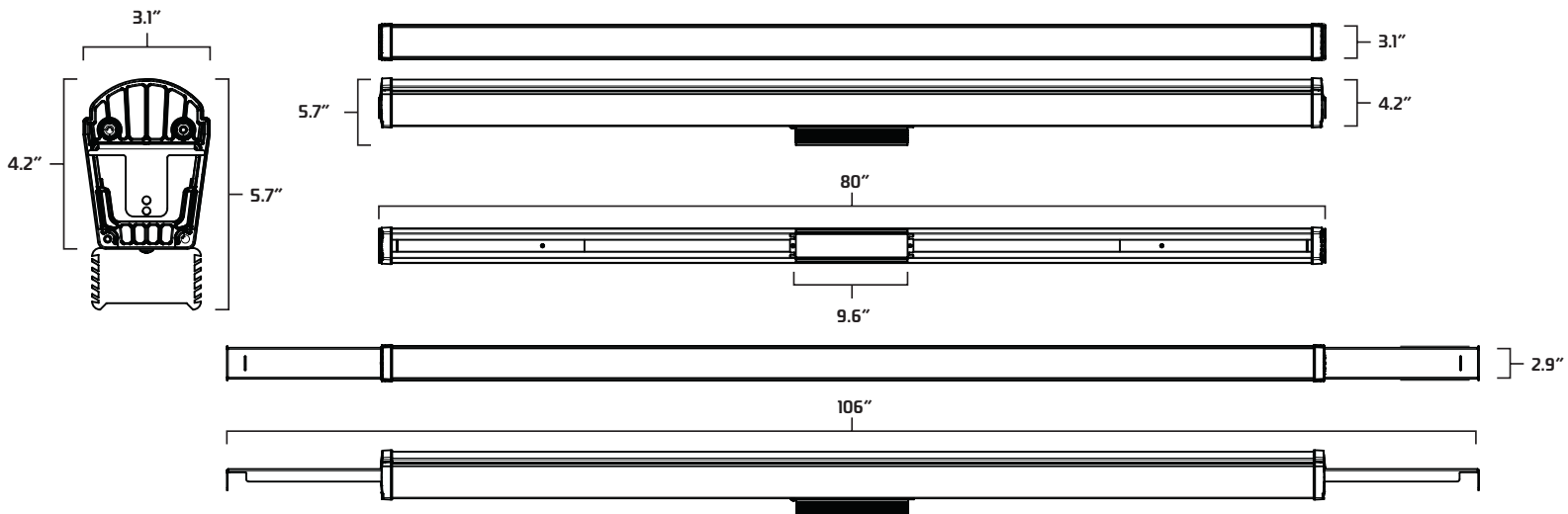

Catalyst® Pro Specifications

	CA340-3A 340W 34% Red Spectrum	CA340-5A 340W 53% Red Spectrum	CA260-3A 260W 34% Red Spectrum	CA260-5A 260W 53% Red Spectrum					
PPF: (μmol/s) @ 277 VAC	850	930	680	725					
PPE: (μmol/J) @ 277 VAC	2.5	2.8	2.6	2.8					
Controlled Environment	Indoor Stacked (2 Tier) and Non Stacked, Greenhouse								
Lighting Scheme	Intra-Canopy, under canopy, supplemental								
Dimming	0-10V, Dim to Off, LLT M12 Connector								
Certifications	UL 8800 Wet Location, DLC								
Warranty:	5 years								
Installation	Telescoping arms to hang from trellis bars or stands								
Ambient Temperature	40° C max								
Dimensions	Min: 4.5"H x 3"W x 80"L Max: 4.5"H x 3"W x 106"L								
Weight	11 lbs								
Options	Telescoping arms or stands								
AC Input	115-277 VAC								
Current/ Power	115VAC	3.00A	346W	3.00A	346W	2.34A	269W	2.34A	269W
	220VAC	1.56A	344W	1.56A	344W	1.21A	267W	1.21A	267W
	277VAC	1.23A	340W	1.23A	340W	0.95A	264W	0.95A	264W

Spectrums

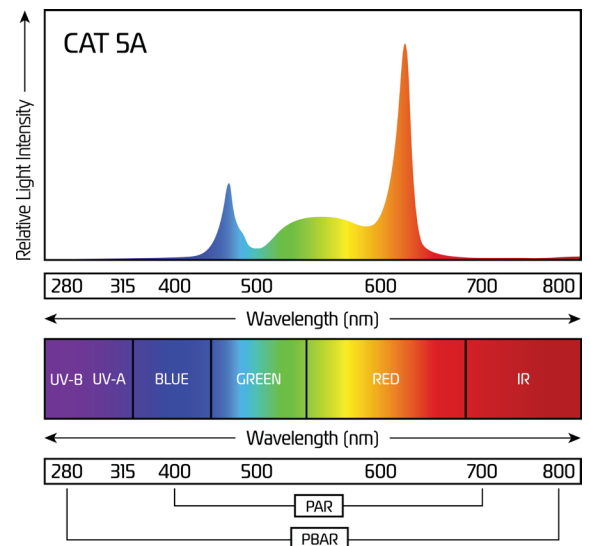
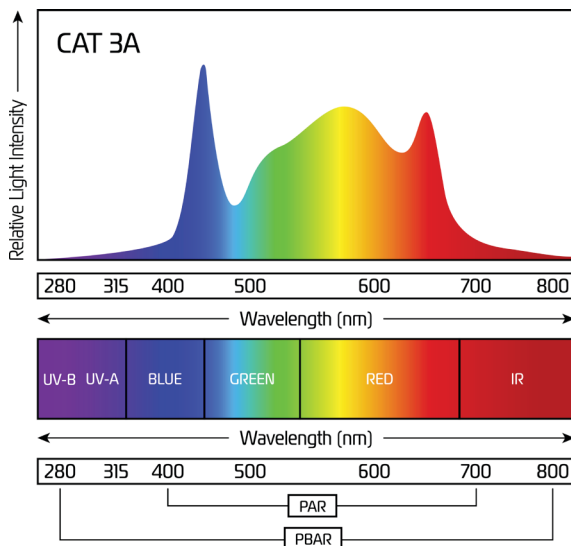

Ratios

